

Scheda alunno

La catacomba cristiana

Ritaglia, incolla e colora i disegni della catacomba cristiana.

In questa uscita trovi il terzo piano sotterraneo. Seguendo le indicazioni della legenda dei simboli, individua il simbolo (per questa uscita l'anima) e incolla la figurina corrispondente rappresentativa dell'arte paleocristiana (in questa uscita l'orante, la cerva e la colomba).

13

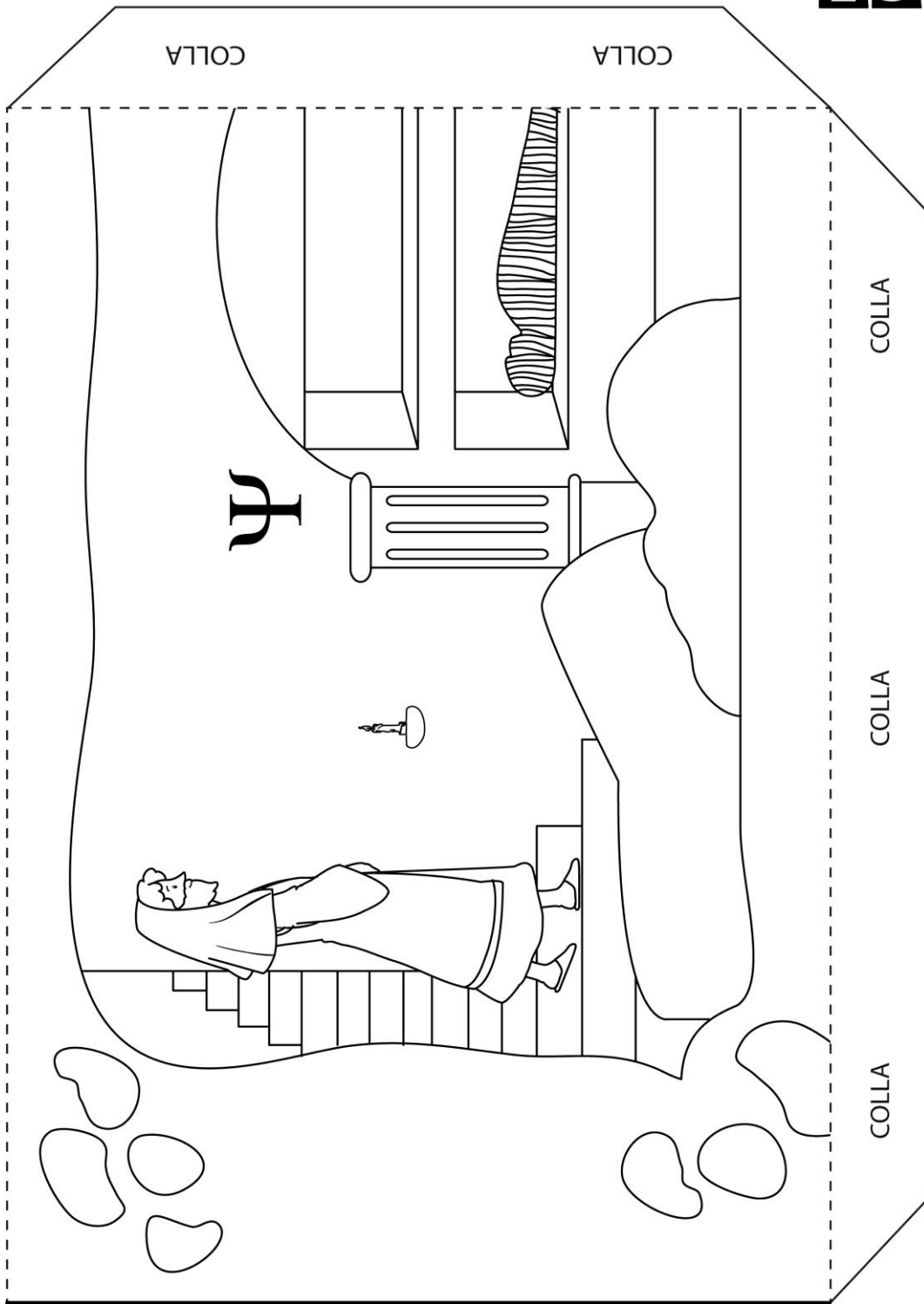



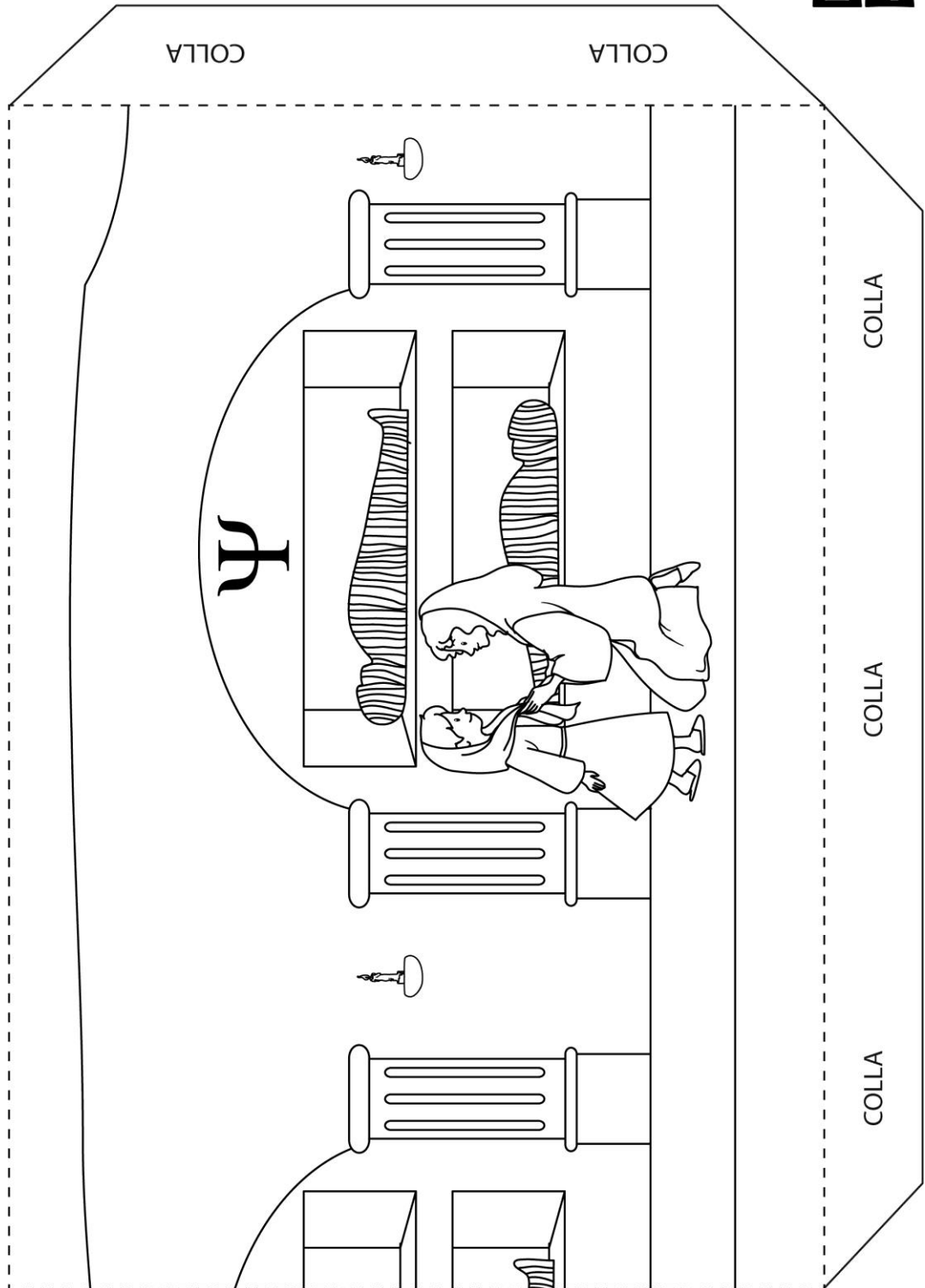

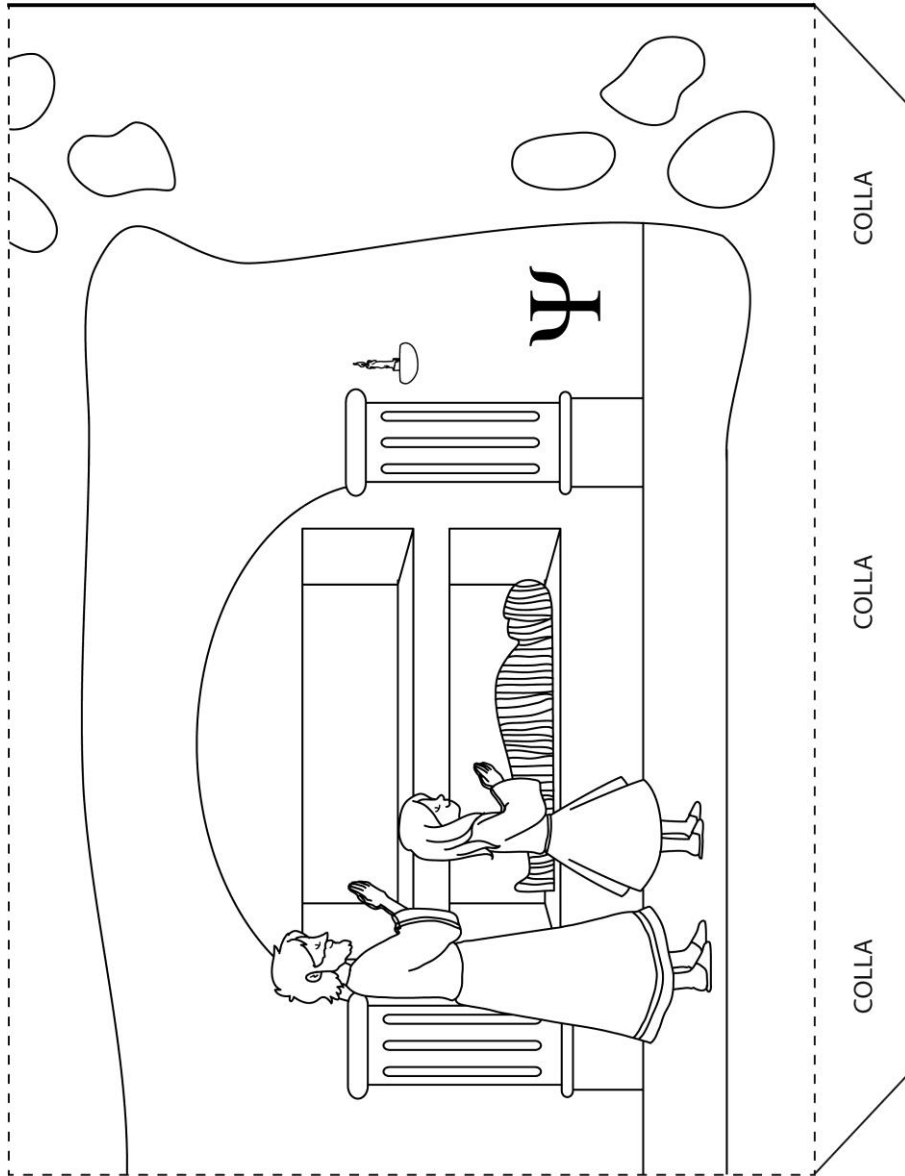

14



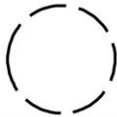



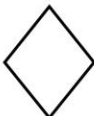

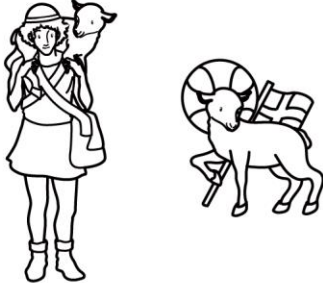

1/5

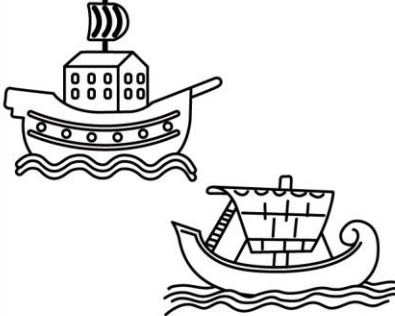

LEGENDA

SIMBOLI CRISTIANI	SIGNIFICATO
	GESÚ
	CHIESA
	SPIRITO
	ANIMA
	FEDE
	RISURREZIONE

LEGENDA	SIMBOLI DELL'ARTE PALEOCRISTIANA	INVENTO I MIEI SIMBOLI
<p>GESÚ</p> <p>=</p> 		
<p>CHIESA</p> <p>=</p> 		
<p>SPIRITO</p> <p>=</p> 		
<p>ANIMA</p> <p>=</p> 		

SIMBOLI CRISTIANI	SIMBOLI DELL'ARTE PALEOCRISTIANA	I MIEI SIMBOLI
FEDE = 		
RISURREZIONE = 		





ORANTE



COLOMBA

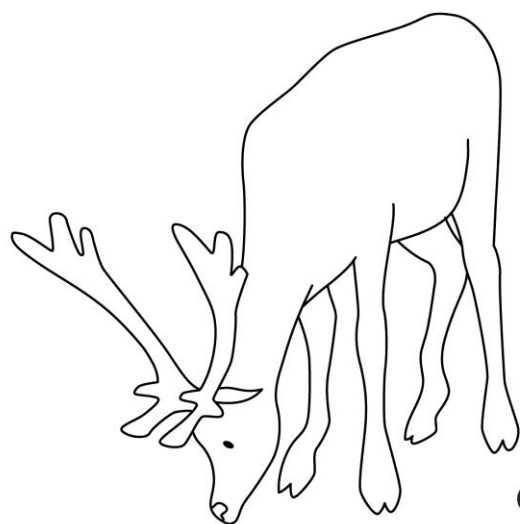

CERVO